

GRADES
K-6

UNDERSTANDING CHRISTIAN SYMBOLS

Chalice

Printable Lesson Kit



M **GHTY MESSAGES**

THANK YOU

Thank you for ordering from www.TeachSundaySchool.com. We strive to offer you top notch Bible teaching tools. Feel free to contact us with any questions a marykate@teachsundayschool.com.

HOW TO PRINT

If you are having any trouble printing, here are some helpful tips:

- 1) Adobe Acrobat PDF Reader is the most universal PDF reader and comes standard on most computers. If you are having issues, check to make sure you are using a recent version of Adobe, which is available free online here.
- 2) If for any reason a page is being cut off, when you push the “print” button and the dialogue box pops up, check the box “fit”.

TERMS OF USE

The material enclosed is copyrighted. You do not have resell rights or giveaway rights to the material provided herein. Only customers that have purchased this material are authorized to view it.

Allowed:

You are able to print as many times as you would like for personal, family, or single church/school use. (Please show this to any printer you may take this to in order to prove that you are not infringing on the copyright by printing this file).

If you would like to use this file for multiple schools or churches, please email us at marykate@teachsundayschool.com for information on a bundle purchase price.

Not Allowed:

This digital file cannot be given to anyone else. In order to own a digital file, it must be purchased. This file is never to be emailed to anyone else for the purpose of giving it to them or sharing it with them. In order to own a file, it must be purchased.

Do not post this file, or images from this file on a blog, website, or anything like it for the purpose of giving it away or selling it.

Do not change this file in any way.

Do not use all or part of this file for commercial use in any way.

Anything that is not meant for the intended use of this file, which is for personal, family, or single church/school use is not allowed. We are offering this as a digital file for the convenience of our customers. Any abuse of that is not allowed.

If you feel you have obtained an unauthorized copy of this material, please email us at marykate@teachsundayschool.com.

LEGAL NOTICE

While all attempts have been made to verify information provided in this publication, neither the author nor the publisher assumes any responsibility for errors, omissions or contrary interpretation of the subject matter herein. The publisher wants to stress that the information contained herein may be subject to varying state and / or local laws or regulations. All users are advised to retain competent counsel to determine what state and / or local laws or regulations may apply to the user’s particular operation.

The purchaser or reader of this publication assumes responsibility for the use of these materials and information. Adherence to all applicable laws and regulations, federal, state and local, governing professional licensing, operation practices, and all other aspects of operation in the US or any other jurisdiction is the sole responsibility of the purchaser or reader. The publisher and author assume no responsibility or liability whatsoever on the behalf of any purchaser or reader of these materials. Any perceived slights of specific people or organizations is unintentional.

CONTENTS

Lesson Overview	4
Scripture & Lesson	5
Printable Craft	7
Coloring Page	9
Word Search	11
Crossword Puzzle	12
At-A-Glance	13
Take Home Fun Page	14
Learning Lookups	15
Quiz	16
Answer Key	17
Certificate of Completion	18



LESSON OVERVIEW

CHALICE MIGHTY MESSAGES

This lesson on the origins of the cup, or chalice, used by Christ at the Last Supper will give kids some background on Holy Communion and what the symbol means in our faith. They will better understand the symbols of the body and blood of Christ.

How to Use the Lesson Kit:

This lesson contains many activities to help children in K-6 grade understand the subject. Feel free to fix and match activities to those that you feel will be age appropriate to your kids!



WHAT'S INCLUDED:

- Scripture Reading & Lesson
- Discussion Questions
- Printable Craft
- Coloring Page
- Wordsearch
- Crossword Puzzle
- Learning Lookups Journaling
- Quiz
- Reference Sheet
- Certificate of Completion
- Answer Page



MATERIALS LIST:

- A picture or image of the chalice, either printed or on your phone (Chalice coloring sheet can also work for this)
- Crayons
- Glue sticks
- Scissors
- White Paper or Cardstock
- Pencils or pens
- Bibles (electronic or hardcopy)



SCRIPTURE & LESSON

PASSAGE (NIV): VARIOUS PASSAGES ABOUT THE SYMBOL

Read the following excerpts as shown (NIV translation), or read from your chosen Bible translation:



Luke 22:19-20

And he took bread, gave thanks and broke it, and gave it to them, saying, “This is my body given for you; do this in remembrance of me.” In the same way, after the supper he took the cup, saying, “This cup is the new covenant in my blood, which is poured out for you.

1 Corinthians 11:23-26

²³ For I received from the Lord what I also passed on to you: The Lord Jesus, on the night he was betrayed, took bread, ²⁴ and when he had given thanks, he broke it and said, “This is my body, which is for you; do this in remembrance of me.” ²⁵ In the same way, after supper he took the cup, saying, “This cup is the new covenant in my blood; do this, whenever you drink it, in remembrance of me.” ²⁶ For whenever you eat this bread and drink this cup, you proclaim the Lord’s death until he comes.

Questions for Children

- 1. The Chalice is the cup that held the wine on the night Jesus introduced his disciples to Holy Communion. It symbolizes our bond with God and Jesus. The bond comes to us from participating in communion and following God's will. What do you think they are?** *Praying, speaking to God, and listening for his voice.*
- 2. In some cases, the Chalice is called the Holy Grail. Rumors have existed for centuries that the Holy Grail still exists, hidden or buried somewhere like a hidden treasure. Why do you think no one has ever found it?** *God does not want us getting too intrigued or fixated on things that Jesus or the prophets touched. They can too easily turn to idols.*
- 3. The idea symbolized by the Chalice is to mix Christ's blood with our blood, and the symbol of the bread is for his body to become one with our bodies. Why are these concepts so important?** *It means Christ is not just with us but in us. Christ can lead and guide us and we can hear his voice in our hearts. It means we are clean and spirit-filled.*



TEACHER'S MIGHTY MESSAGE

Throughout your message, keep visible a copy of your coloring sheet, containing the symbol, which you can point to.

The Chalice is one of the well-known symbols of our faith. It means that we admit Jesus is the Son of God, and we believe his body and blood can help free us of the power of sins and wrongdoings. It symbolizes cleanness of spirit.

We don't generally like to talk of blood. When we do, we think of skinned knees and stitches at Urgent Care. We think of accidents. The blood of Jesus is different. It should make us think of healthy blood coursing through our bodies. We should think of health—both spiritual and physical. When we participate in Communion, it makes Christ's blood one with our blood. It is making our minds and hearts right.

For centuries, treasure hunters have been looking for the Chalice from which Jesus drank. This is one of many symbols, many items mentioned in the Bible that people can't seem to find. Others include the Ark of the Covenant as well as Noah's Ark, which was a big boat and different from the Ark of the Covenant. That Ark of the Covenant was made by the Hebrew people during the Exodus through specific instructions from God himself. It contained the Ten Commandments. Treasure hunters have looked for the nails that went through Jesus' hands. They've looked for the robe he wore that the soldiers gambled for at the crucifixion. Very few relics have actually been found. Many said to be found have proven to be frauds.

Some churches in Europe and Africa believe they have pieces of the wood of the cross. There has also been a lot of discussion about a mysterious piece of cloth called the Shroud of Turin, which some believe covered Jesus' body. It has the imprint on it of a man who had obviously been crucified, beaten, and who bled severely.

But the Chalice, the arks, and other pieces of interest remain missing. The Ark of the Covenant is spoken of in the Book of Revelation, which is about the future, as being in heaven.

The reason is that we are easily distracted from spiritual matters by material things. Instead of enjoying a deeper relationship with Christ over these things, people would start to rely on them—for healing, help, hope, wisdom. Before long we'd have idols to distract us.

We will see the beautiful chalice in heaven when we get there. We'll see the Ark of the Covenant and the crown of thorns and all sorts of great pieces of history. Until then, we need to stick to the plan God laid out for us. Pray, appreciate, listen for God's voice, and when you are old enough, take Communion with your fellow believers.





MATERIALS:

- 3D Chalice Craft Printable File (two pages)
- White Paper or Cardstock
- Coloring Utensils
- Scissors
- Glue



PREPARATION:

- Print one copy of Chalice Craft for each student

INSTRUCTIONS:

1. Color images as desired
2. Carefully cut out chalice shapes
3. Fold back tabs for each shape and slightly curve each piece in preparation for gluing
4. Starting with cup of chalice, add glue to one side and align with diagonal guide box. Once firmly adhered, glue tab on other side of chalice up to corresponding diagonal box. Then glue and tuck under cup bottom.
5. Next with stem of chalice, glue tab on one side of vertical guide boxes. Once firmly adhered, move on to other tab and add glue, tuck under, and align with other vertical guide box.
5. Last, for Chalice bottom, add glue to one side and align with diagonal guide box. Once firmly adhered, glue other tab to other guide box.

Introduction or Conclusion

The Chalice is a symbol of our unity with God, Jesus, and the Holy Spirit. The Holy Spirit lives in our hearts, so we are kind of like chalices too! See how all of yours look different? Just like these cups we are all different. We have different strengths, weaknesses, and gifts, but we are carrying the love of God to all we meet!

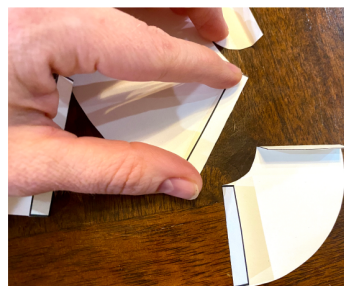
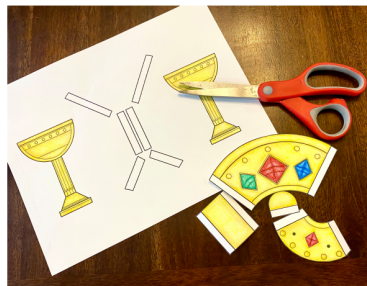

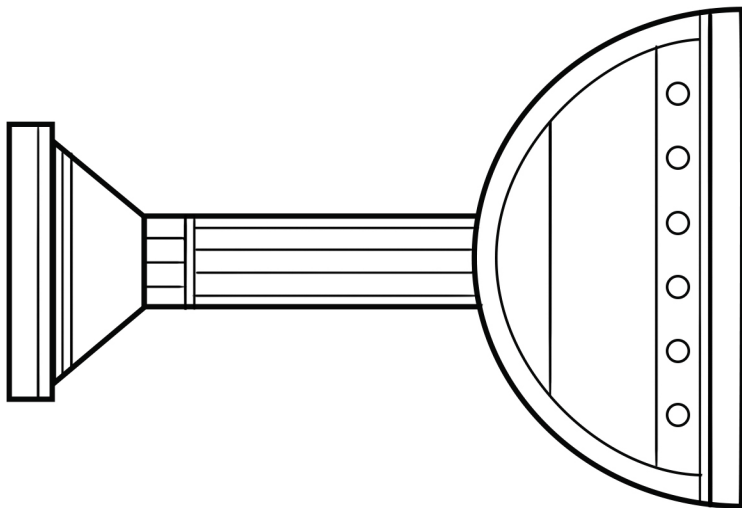
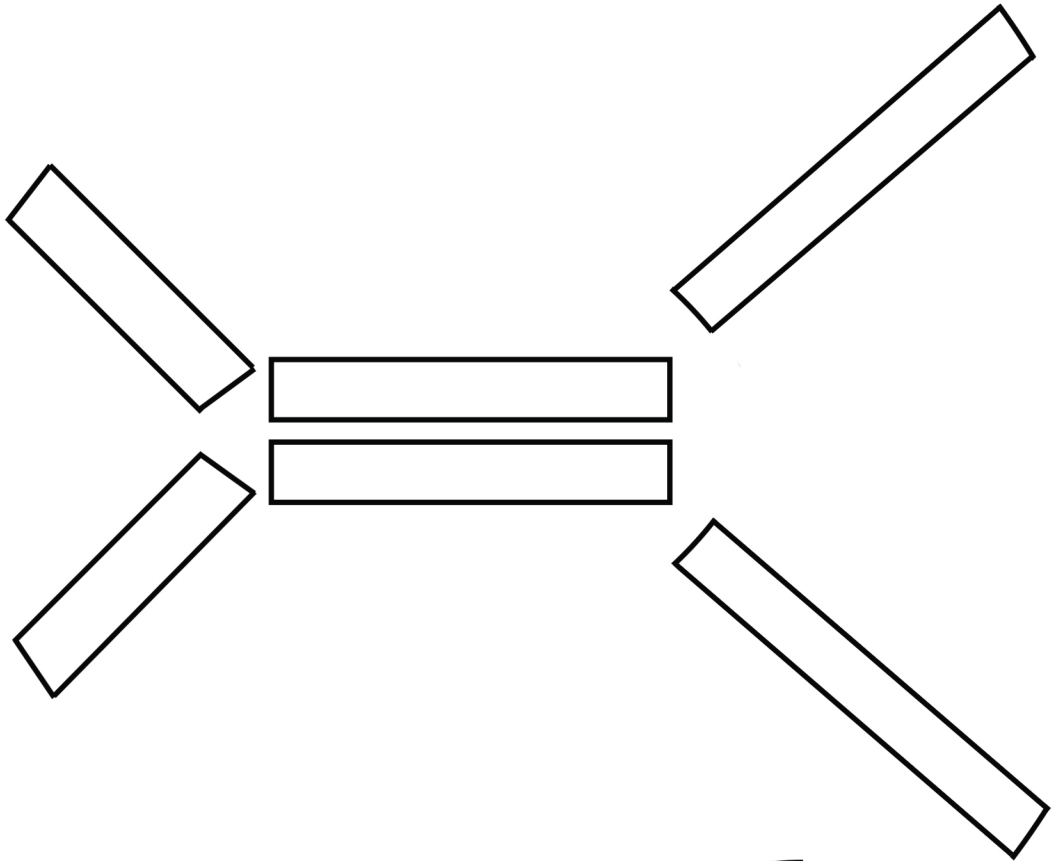
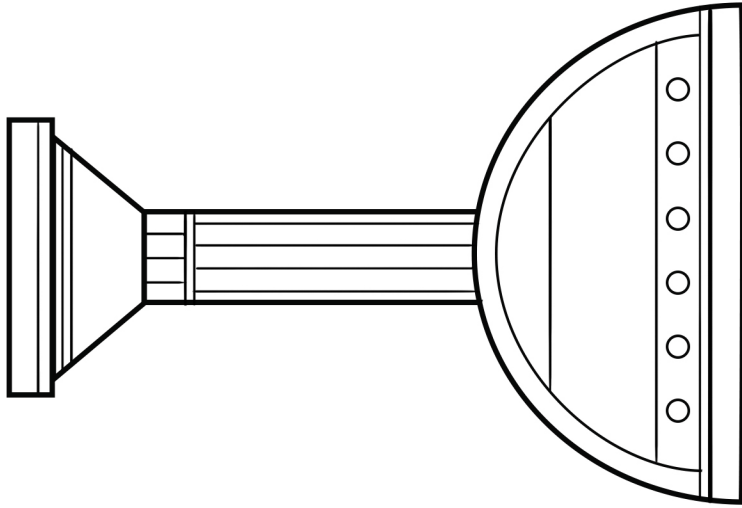

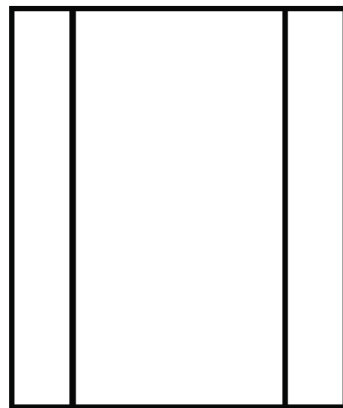
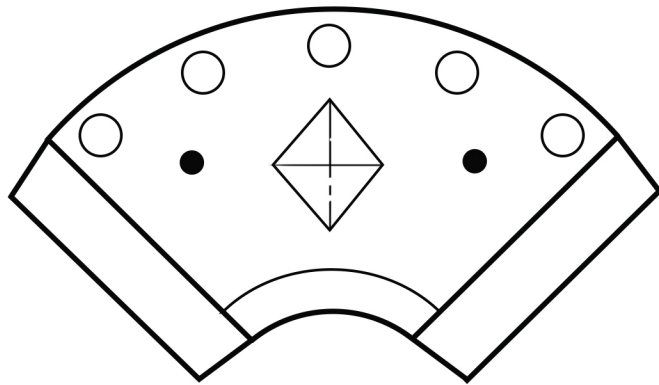
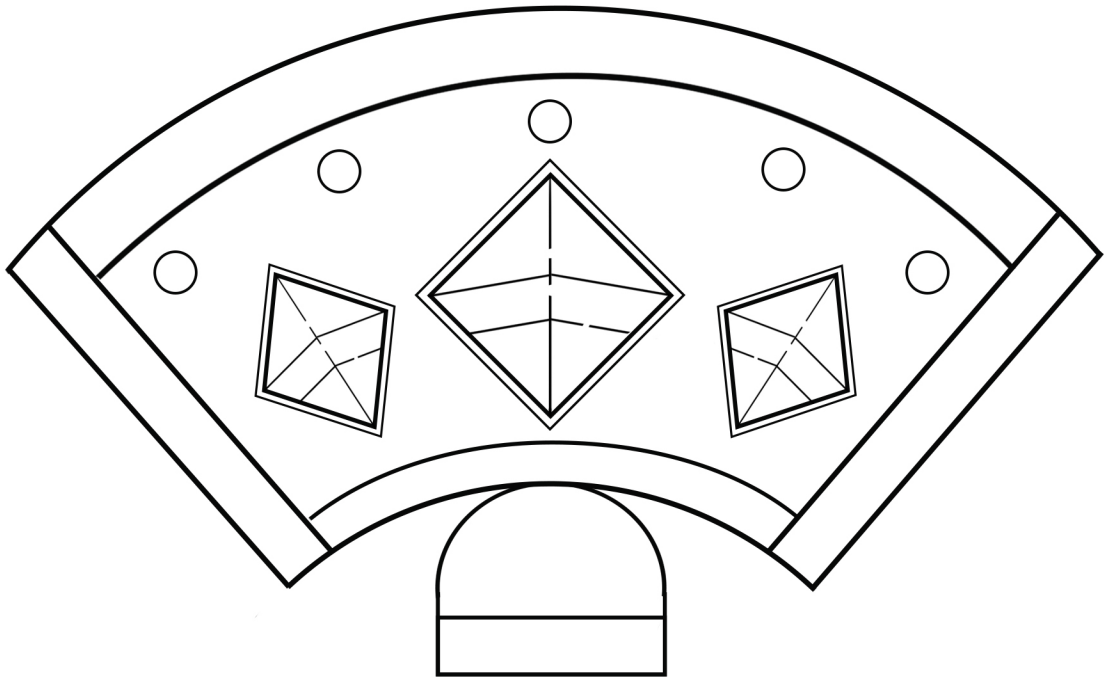

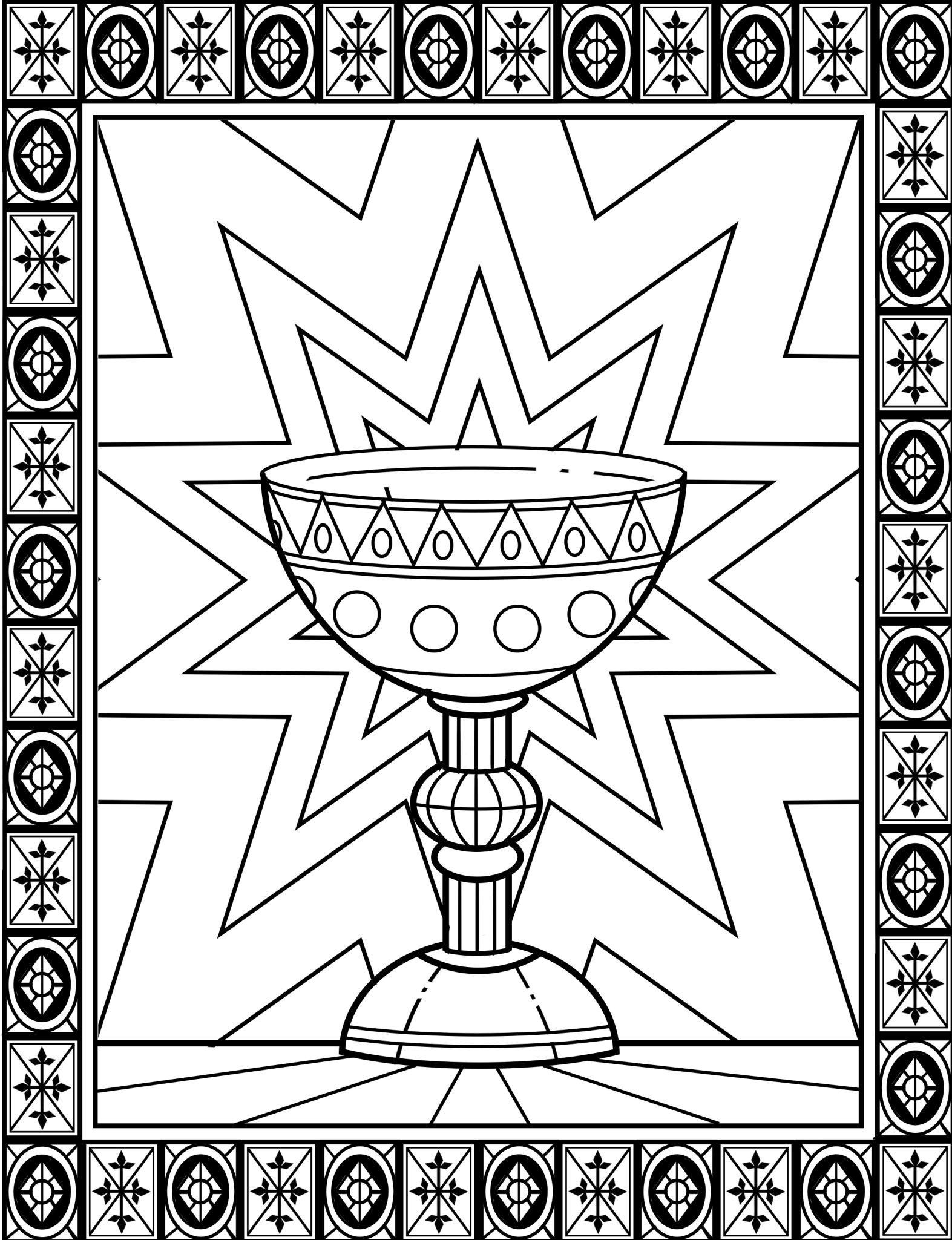



WORD SEARCH

Instructions: All sorts of relics exist that people would like to find, like the Chalice, also known as the Holy Grail. Below are a few of them. They are hidden on earth just like the words are hidden in the word-search puzzle below. Find them.

F	T	S	B	O	N	E	S	C	Y	F	W
F	J	M	L	O	I	A	W	I	U	B	X
E	O	U	E	J	O	D	H	A	D	L	T
T	N	F	T	G	K	K	Y	L	O	O	I
U	S	U	T	A	R	K	S	E	C	O	Z
N	K	C	E	C	B	M	R	P	U	D	C
I	U	R	R	R	Y	L	I	I	M	S	H
C	L	O	S	O	G	P	E	S	E	T	A
W	L	S	P	W	L	U	U	T	N	A	L
T	S	S	E	N	Q	L	H	L	T	I	I
T	Y	T	A	S	M	Q	W	E	S	N	C
N	W	B	R	N	A	I	L	S	W	S	E

Words to Find:

**TABLET
SCROLL
LETTERS
EPISTLES**

**DOCUMENTS
CHALICE
NAILS
CROSS**

**TOMB
CROWNS
BONES
SPEAR**

**UNIC
ARKS
BLOODSTAINS
SKULLS
BOOKS**



CROSSWORD PUZZLE

Instructions: Use your At-A-Glance Sheet, Famous Scriptures about Holy Communion, to complete the answers to the crossword puzzle below.

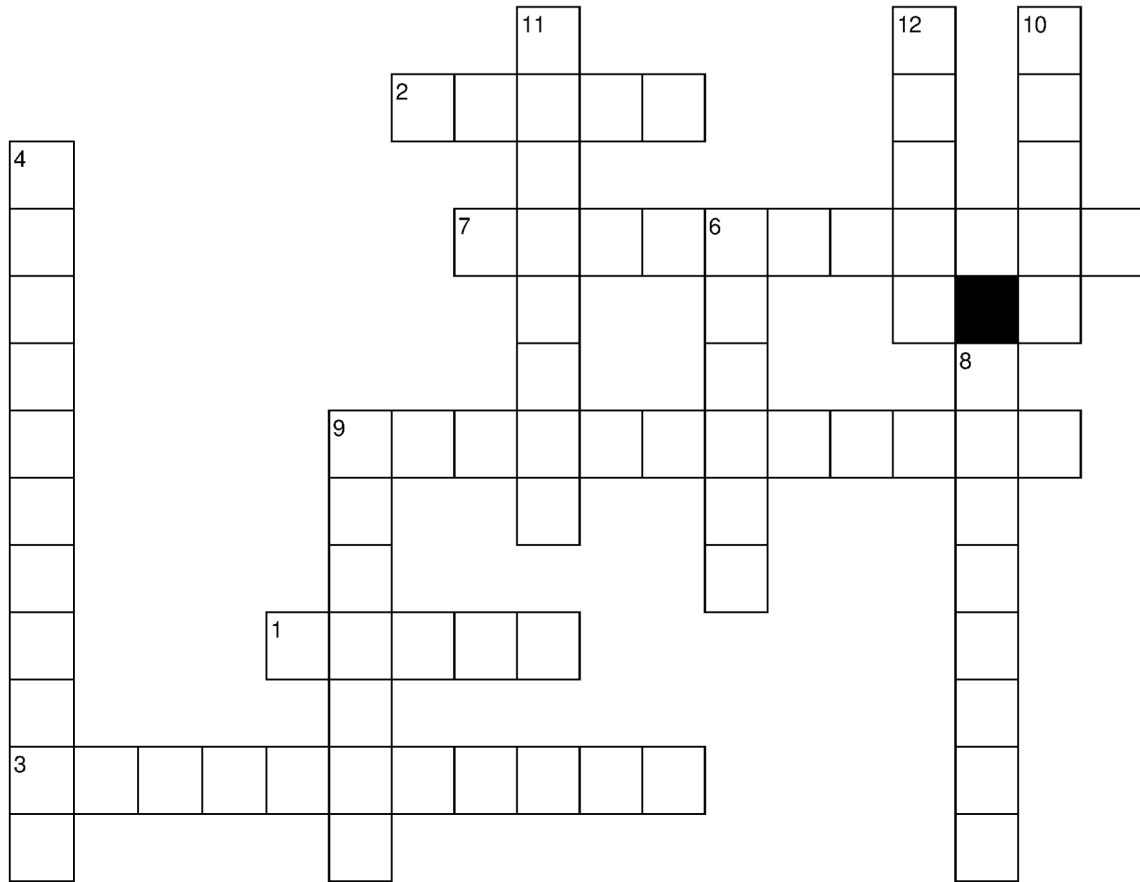

Across

1. The symbol for Christ's body in Luke 22:19-20
2. Symbol in Luke 22:19-20 that is Christ's and poured out for us
3. Bible book where the Holy Communion story repeats the stories in the gospels
7. An early king mentioned in Genesis as foreshadowing Holy Communion
9. 1 Corinthians 10:16 Refers to the chalice as the cup of...

Down

4. A word used in 1 Corinthians 11:23-26 that means to look back on, reflect on, and appreciate
6. I am the bread of life whoever comes to me will never be...
8. According to 1 Corinthians 11:27, we should not take Holy Communion in this manner
9. Whoever believes in me will never be...
10. 1 Corinthians 11:26 tells us to celebrate the Lord's death via Holy Communion until he...
11. According to Luke 22:20 the Chalice symbolizes the new...
12. Melchizedek was the King of this region



AT A GLANCE: FAMOUS SCRIPTURES ABOUT HOLY COMMUNION

Below are scriptures most noted for helping to form the symbols of the Chalice and also the bread that goes with the wine the Chalice held. Two of these verses should be extremely familiar, as one or the other is recited when communion is served. Mark them with an X.

LUKE 22:19-20

And he took bread, gave thanks and broke it, and gave it to them, saying, "This is my body given for you; do this in remembrance of me." In the same way, after the supper he took the cup, saying, "This cup is the new covenant in my blood, which is poured out for you."

1 CORINTHIANS 11:23-26

²³ For I received from the Lord what I also passed on to you: The Lord Jesus, on the night he was betrayed, took bread, ²⁴ and when he had given thanks, he broke it and said, "This is my body, which is for you; do this in remembrance of me." ²⁵ In the same way, after supper he took the cup, saying, "This cup is the new covenant in my blood; do this, whenever you drink it, in remembrance of me." ²⁶ For whenever you eat this bread and drink this cup, you proclaim the Lord's death until he comes.

1 CORINTHIANS 10:16

Is not the cup of thanksgiving for which we give thanks a participation in the blood of Christ? And is not the bread that we break a participation in the body of Christ?

JOHN 6:35

Then Jesus declared, "I am the bread of life. Whoever comes to me will never go hungry, and whoever believes in me will never be thirsty."

GENESIS 14:18

Then Melchizedek king of Salem brought out bread and wine. He was priest of God Most High...

1 CORINTHIANS 11:27

So then, whoever eats the bread or drinks the cup of the Lord in an unworthy manner will be guilty of sinning against the body and blood of the Lord.

Connect the Dots!

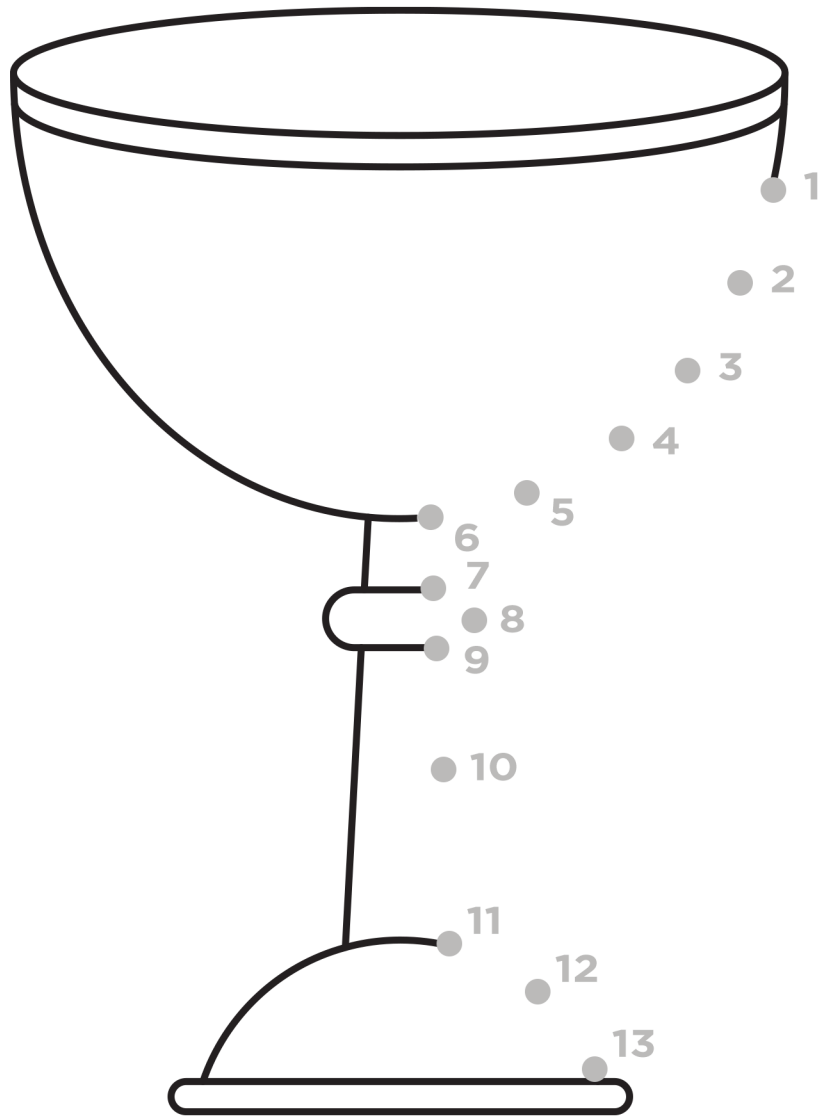

Write out the following important scripture for this symbol: Luke 22:20



LEARNING LOOKUPS



CHRISTIAN SYMBOLS *Chalice*

Lookup: John 6:35 and write it down.

Lookup: Genesis 14:18 and write it down.

Question: The first statement was made by Jesus shortly before he created Communion. The second happened 2,000 years before Jesus was born. Both are called “foreshadowing.” Why do you think God often had things happen that pointed to future events?

Create a prayer below. Speak to God and write it. Ask God to make clear some things he will do in the future if you seek him diligently. Use your own words:

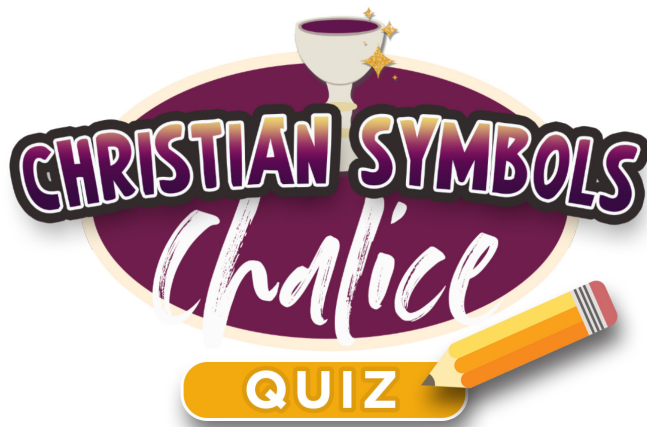

Instructions: Use your At-A-Glance Sheet to fill in the scripture verses below that have to do with the Chalice symbol and Communion

THE CHALICE IN THE BIBLE

Luke 22:19-20: And he took bread, gave thanks and broke it, and gave it to them, saying, "This is my _____ given for you; do this in remembrance of me." In the same way, after the supper he took the cup, saying, "This cup is the new covenant in my _____, which is poured out for you.

1 Corinthians 11:23-26: ²³ For I received from the Lord what I also passed on to you: The Lord Jesus, on the night he was betrayed, took _____, ²⁴ and when he had given thanks, he broke it and said, "This is my body, which is for you; do this in remembrance of me." ²⁵ In the same way, after supper he took the _____, saying, "This cup is the new covenant in my blood; do this, whenever you drink it, in remembrance of me." ²⁶ For whenever you eat this bread and drink this cup, you proclaim the Lord's death until he comes.

1 Corinthians 10:16: Is not the cup of _____ for which we give thanks a participation in the blood of Christ? And is not the bread that we break a _____ in the body of Christ?

John 6:35: Then Jesus declared, "I am the bread of life. Whoever comes to me will never go _____, and whoever believes in me will never be _____.

Genesis 14:18: Then Melchizedek king of _____ brought out bread and wine. He was priest of God Most _____...

1 Corinthians 11:27: So then, whoever eats the bread or drinks the cup of the Lord in an _____ manner will be guilty of _____ against the body and blood of the Lord.



ANSWER KEY

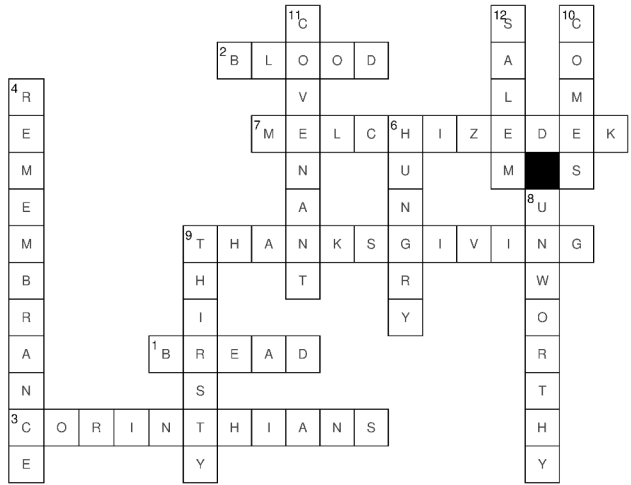
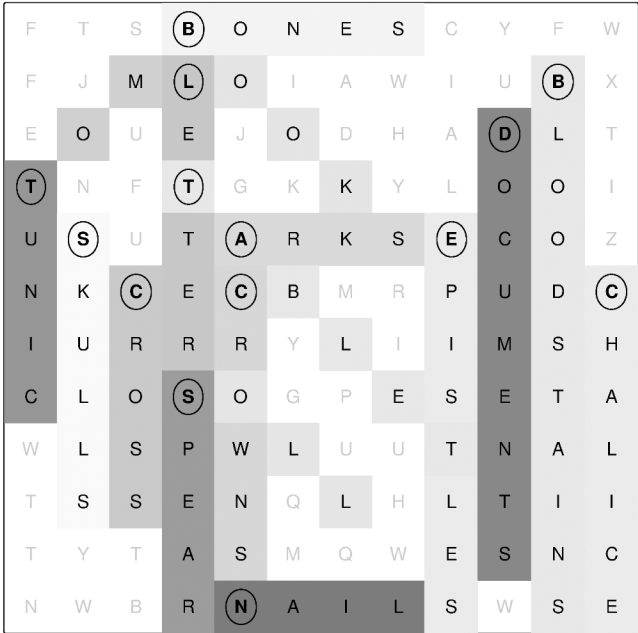

Teacher's QUIZ ANSWERS in order:

- 1) body
- 2) blood
- 3) bread
- 4) cup
- 5) thanksgiving
- 6) participation
- 7) hungry
- 8) thirsty
- 9.) Salem
- 10) high
- 11) unworthy
- 12) sinning

CHRISTIAN SYMBOLS

Traveller

CERTIFICATE OF COMPLETION



NAME:

DATE: